



InfraRack S6 Standalone Series

To meet the increasing demands of data centers, Austin Hughes have launched the latest on rack intelligence.

InfraRack S6 series is the perfect but affordable solution that provides an easy approach to the rack essentials in the 21st century data centers.

Key Benefits

>>> Rack Standard for Next Generation Data Centers

Today's data center have to be well-managed, more efficient and powerful. InfraRack S6 integrates smartcard security & auto lighting solutions to provide data center with an intelligent rack approach.

>>> Standalone Rack Access Control

Rack level access security has become critically important for data centers. InfraRack is integrated with pair of smartcard handles with dual locking systems (electronics & mechanical lock).

>>> High Quality Illumination

InfraRack S6 bundles with stylish LED light bar for rack level illumination. By the integrated IR sensor, the LED light bar provides the Auto ON / OFF mode. Magnetic base design for tool-less affix & flexible positioning.

>>> Plug & Play

The smartcard handles, LED light bar & door sensors are well-integrated to the InfraRack with cabling. Moreover, one authenticated smartcard is bundled. A new InfraRack S6 delivered is ready to use once power on.

>>> High Quality IT Rack

Well-engineered InfraRack covers heavy duty & medium duty series for a variety of requirement.

>>> Proximity & MiFARE Compatible



Compatibility issues between different access card standards are a major consideration when deploying a smartcard system. InfraRack S6 standalone series caters for the two most common smartcard alternatives – the Proximity & MiFARE.

>>> Access Control

The patented **InfraSolution® S-600** standalone smartcard handle is designed for rack level access security of all data centers and server rooms at affordable prices. LED color modes on the smartcard handle indicate the lock status clearly that even authorized unlock and unauthorized rack access can be distinguished. Optional dual card authentication rack access by administrator and user cards is available from S-600 series.



Patented and Worldwide Patents

S-600P	Features	S-600M		
 <div style="border: 1px solid black; padding: 2px; width: fit-content; margin: auto;">PROXIMITY SMARTCARD</div>	Intelligent design with patent	 <div style="border: 1px solid black; padding: 2px; width: fit-content; margin: auto;">MiFARE SMARTCARD</div>		
	✓		Proximity 26-bit smartcard compatible	
			MiFARE 26-bit smartcard compatible	✓
			Dual locking system (electronics and mechanical lock)	
			Electronic lock released either by smartcard or software	
			Rack access status and alarm indication by LED	
			Individual key lock option available	
			Support 3-pt lock mechanism	

Stylish Mechanical Design

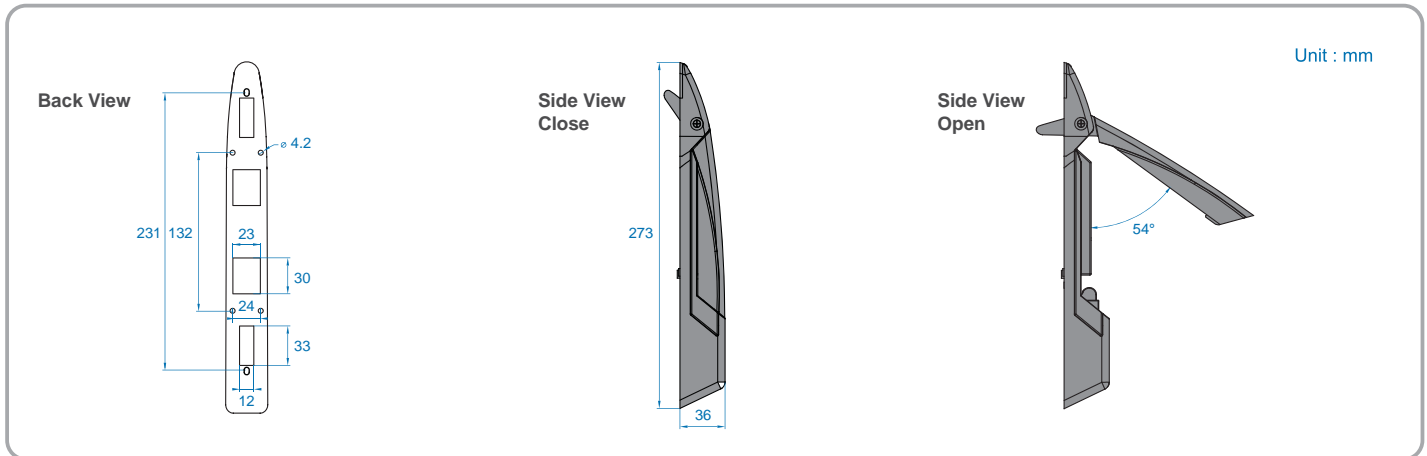

Connection Diagram

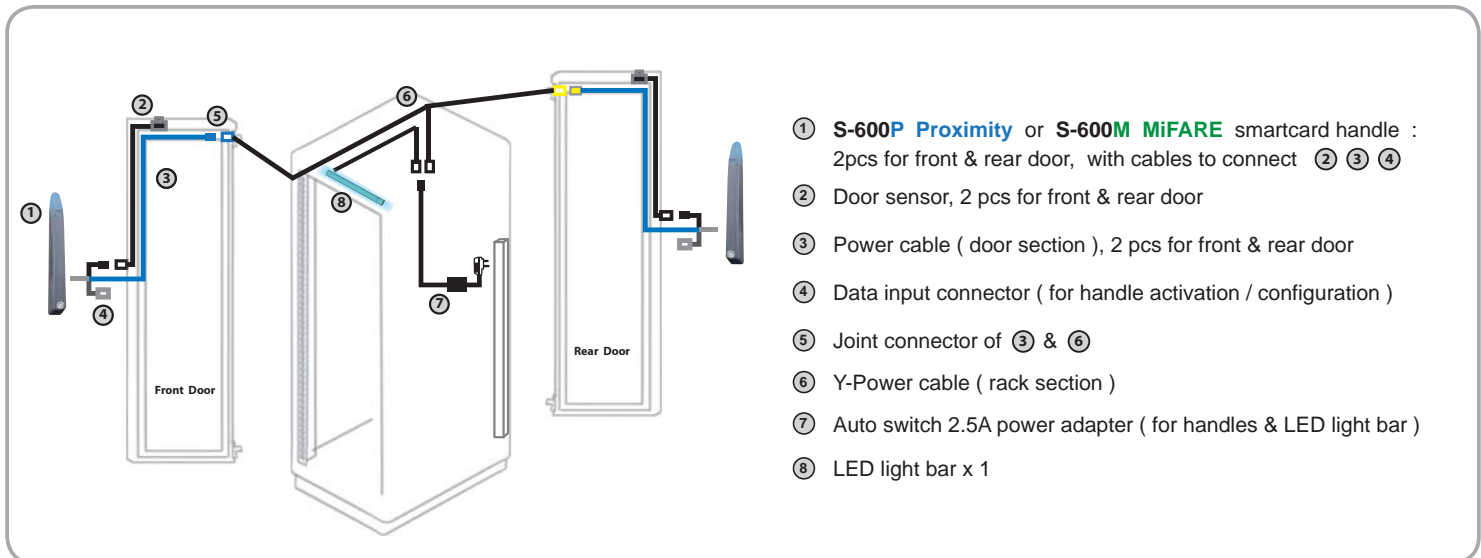

Handle LED for Lock Status Indication

The LED color on InfraSolution S standalone smartcard handle provides the clear indication on the lock status. User can view the handle lock status just by LED handle colors.



Free & User Friendly Utilities (ISU-01)

InfraRack S6 series provides a free GUI for smartcard authorization in a quick & simple way :

- Max. 50 user card can be authorized per handle
- Dual card authentication available for further security requirement

Handle Information

Handle ID: SHID-01FD701BE8A
 Model no.: S-600P
 Type: Proximity
 Last updated: 2013 / 04 / 16 17:09

Handle Location

Zone: Demo_Zone_A
 Rack: Demo_Rack_A
 Handle position: Front Rear

Door Sensor

Disable Enable
 Ensure you have ordered door sensors and finished the installation and connection. Otherwise, DO NOT enable door sensor as it will cause malfunction.

Card Access Mode

Normal (User card only)
 Dual card authentication (Administrator card + User card)

Buttons: Apply, Cancel, Export, Import

Status: Synchronizing data with handle [SHID-01FD701BE8A].....100%

Card Assignment (Max. 50)

	Card edit	Delete	
1	00104531	26	00104558
2	00026156	27	00104599
3	10800074	28	00104781
4	00105208	29	00105310
5	10803508	30	10804577
6	10803513	31	10804567
7	10803512	32	10804598
8	00104532	33	10804599
9	10800077	34	00103511
10	00105308	35	00103519
11	00105209	36	00026151
12	00104534	37	00026152
13	10803353	38	00026153
14	10803325	39	00026157
15	00026155	40	00026161
16	00026158	41	10806778
17	10800088	42	10806779
18	10800079	43	10806888
19	00104452	44	10806887
20	00104623	45	00105533
21	00104618	46	00105539
22	00105311	47	00105535
23	00105671	48	00104533
24	00105669	49	00104538
25	00105666	50	10808867

Free LED Light Bar (CLB-SD-IR-101)

- InfraRack S6 series bundles with a free LED light bar
- LED light bar auto ON / OFF by door status change
- Magnetic base & low profile design



>>> Infra-S6-SR Heavy Duty Rack



SR Key Highlights

- Heavy duty server rack
- Access control w/ **MiFare** or **Proximity** smartcard handle x 2
- LED light bar x 1
- 600 & 800 wide models meet up-to-date requirements of global data center
- Perforated rack doors ensure ideal airflow direction
- Well-engineered to accommodate tool-less mounting PDU x 4
- Framework allows multi-dimensional cable pathways and numerous efficient cabling options
- Easy to deploy and adaptable to Aisle containment to achieve efficient airflow management
- Quick release mechanism design for doors and split side panels
- Tool-less adjustment for front and rear 19" rails



REACH

600W	Package No.	Width		Depth				Height			
				Overall (door to door)		Effective (frame to frame)		Overall (w/ casters)		Effective	
		mm	inch	mm	inch	mm	inch	mm	inch	mm	inch
42U	Infra-S6-SR-6042	600	24"	1072	42"	1000	39"	2035	80"	1867	74"
	Infra-S6-SR-6242	600	24"	1200	47"	1128	44"	2035	80"	1867	74"
45U	Infra-S6-SR-6045	600	24"	1072	42"	1000	39"	2168	85"	2000	79"
	Infra-S6-SR-6245	600	24"	1200	47"	1128	44"	2168	85"	2000	79"
47U	Infra-S6-SR-6047	600	24"	1072	42"	1000	39"	2257	89"	2089	82"
	Infra-S6-SR-6247	600	24"	1200	47"	1128	44"	2257	89"	2089	82"
52U	Infra-S6-SR-6252	600	24"	1200	47"	1128	44"	2480	98"	2312	91"



1500 kg 3300 lb



MiFare package - Add **M** on the model no., sample : Infra-S6-SR-6042**M**

** Custom size on request



Proximity package - Add **P** on the model no., sample : Infra-S6-SR-6042**P**

800W	Package No.	Width		Depth				Height			
				Overall (door to door)		Effective (frame to frame)		Overall (w/ casters)		Effective	
		mm	inch	mm	inch	mm	inch	mm	inch	mm	inch
42U	Infra-S6-SR-8042	800	31"	1072	42"	1000	39"	2035	80"	1867	74"
	Infra-S6-SR-8242	800	31"	1200	47"	1128	44"	2035	80"	1867	74"
45U	Infra-S6-SR-8045	800	31"	1072	42"	1000	39"	2168	85"	2000	79"
	Infra-S6-SR-8245	800	31"	1200	47"	1128	44"	2168	85"	2000	79"
47U	Infra-S6-SR-8047	800	31"	1072	42"	1000	39"	2257	89"	2089	82"
	Infra-S6-SR-8247	800	31"	1200	47"	1128	44"	2257	89"	2089	82"
52U	Infra-S6-SR-8252	800	31"	1200	47"	1128	44"	2480	98"	2312	91"



1500 kg 3300 lb



MiFare package - Add **M** on the model no., sample : Infra-S6-SR-8042**M**

** Custom size on request



Proximity package - Add **P** on the model no., sample : Infra-S6-SR-8042**P**

SR 600W Heavy Duty Rack

Standard Split

Quick access design for service from side panel



Fully Perforated

Gives 80% perforated area w/ smartcard handle



Perforated Top

Fully Perforated Middle Split

Space-saving design for narrow aisle w/ smartcard handle



SR 800W Heavy Duty Rack

Standard Split

Quick access design for service from side panel



Fully Perforated

Perforated w/ smartcard handle



Perforated Top

Fully Perforated Middle Split

Space-saving design for narrow aisle w/ smartcard handle



Standard Color

- Black (RAL 9005)
- Grey White (RAL 9002)

** Custom color on request



Fully Perforated Door

- Door ventilation up to 80% perforated area
- Stylish hexagon pattern

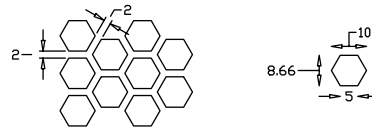

Unit : mm

>>> Infra-S6-NSR Medium Duty Rack



NSR Key Highlights

- Medium duty server rack
- Access control w/ **MiFare** or **Proximity** smartcard handle x 2
- LED light bar x 1
- 600 & 800 wide models meet up-to-date requirements of global data center
- Perforated rack doors ensure ideal airflow direction
- Well-engineered to accommodate tool-less mounting PDU x 2
- Framework allows multi-dimensional cable pathways and numerous efficient cabling options
- Easy to deploy and adaptable to Aisle containment to achieve efficient airflow management
- Quick release mechanism design for doors and split side panels
- Tool-less adjustment for front and rear 19" rails



REACH

600W	Package No.	Width		Depth				Height			
				Overall (door to door)		Effective (frame to frame)		Overall (w/ casters)		Effective	
		mm	inch	mm	inch	mm	inch	mm	inch	mm	inch
42U	Infra-S6-NSR-6042	600	24"	1072	42"	1000	39"	2035	80"	1867	74"
	Infra-S6-NSR-6242	600	24"	1200	47"	1128	44"	2035	80"	1867	74"
45U	Infra-S6-NSR-6045	600	24"	1072	42"	1000	39"	2168	85"	2000	79"
	Infra-S6-NSR-6245	600	24"	1200	47"	1128	44"	2168	85"	2000	79"
47U	Infra-S6-NSR-6047	600	24"	1072	42"	1000	39"	2257	89"	2089	82"
	Infra-S6-NSR-6247	600	24"	1200	47"	1128	44"	2257	89"	2089	82"
52U	Infra-S6-NSR-6252	600	24"	1200	47"	1128	44"	2480	98"	2312	91"



MiFare package - Add **M** on the model no., sample : Infra-X8-NSR-6042**M**

** Custom size on request

1000 kg 2200 lb



Proximity package - Add **P** on the model no., sample : Infra-X8-NSR-6042**P**

800W	Package No.	Width		Depth				Height			
				Overall (door to door)		Effective (frame to frame)		Overall (w/ casters)		Effective	
		mm	inch	mm	inch	mm	inch	mm	inch	mm	inch
42U	Infra-S6-NSR-8042	800	31"	1072	42"	1000	39"	2035	80"	1867	74"
	Infra-S6-NSR-8242	800	31"	1200	47"	1128	44"	2035	80"	1867	74"
45U	Infra-S6-NSR-8045	800	31"	1072	42"	1000	39"	2168	85"	2000	79"
	Infra-S6-NSR-8245	800	31"	1200	47"	1128	44"	2168	85"	2000	79"
47U	Infra-S6-NSR-8047	800	31"	1072	42"	1000	39"	2257	89"	2089	82"
	Infra-S6-NSR-8247	800	31"	1200	47"	1128	44"	2257	89"	2089	82"
52U	Infra-S6-NSR-8252	800	31"	1200	47"	1128	44"	2480	98"	2312	91"



MiFare package - Add **M** on the model no., sample : Infra-X8-NSR-8042**M**

** Custom size on request

750 kg 1650 lb



Proximity package - Add **P** on the model no., sample : Infra-X8-NSR-8042**P**

NSR 600W Medium Duty Rack

Standard Plain

Tool-less installation or removal when maximizing systems or equipment density



Perforated Top



Fully Perforated Middle Split

Space-saving design for narrow aisle w/ smartcard handle

Fully Perforated

Gives 80% perforated area w/ smartcard handle

NSR 800W Medium Duty Rack

Standard Plain

Tool-less installation or removal when maximizing systems or equipment density



Perforated Top



Fully Perforated Middle Split

Space-saving design for narrow aisle w/ smartcard handle

Fully Perforated

Perforated w/ smartcard handle

Standard Color

- Black (RAL 9005)
- Grey White (RAL 9002)

** Custom color on request



Fully Perforated Door

- Door ventilation up to 80% perforated area
- Stylish hexagon pattern

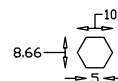
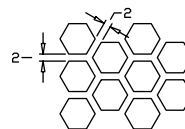

Unit : mm

>>> Options



Dual Card Authentication (DCS-01)

- Software upgrade for additional security
- Rack access by administrator card + user card



Proximity Smartcard, pack of 10 (ISC-P10)

- Proximity 26-bit format
- Single card for multiple application
- Custom card layout available



Handle Data Input Cable, pc (ISW-USB-1.8)

- Connect the smartcard handle to the laptop for handle activation, data input & configuration



MiFARE Smartcard, pack of 10 (ISC-M10)

- MiFARE 26-bit format
- Single card for multiple application
- Custom card layout available



Individual Key Lock (ISK-C051)

- Up to 500 individual key-locks available
- Set of 2 for front & rear door



Warranty Upgrade

- Extension from 2 years to 5 years



Unique Key Lock (ISK-UKL)

- Dedicated to single project / customer regionally
- For project size over 500 racks

Accessories

For the following accessories, please refer to the InfraRack X6 catalogue :
<http://www.austin-hughes.com.hk/support/catalog/CA-IR-X6.pdf>

- Rack PDU
- Rack Fan
- Cabling
- Air Blanking
- Shelf

Austin Hughes has an extensive distribution network,
including the Americas, EMEA, ASEAN & APAC.
Contact your nearest sales office for details of local representation

www.austin-hughes.com.hk

Please ask for details of other products from Austin Hughes. Every effort has been made to ensure that the information contained herein is correct. There is a possibility that the image(s) shown may not be exactly the same as the final product. The company reserves the right to modify product specifications without prior notice and assumes no responsibility for any error which may appear in this publication.

All brand names, logo and registered trademarks are properties of their respective owners.

Copyright 2019 Austin Hughes Electronics Ltd. All rights reserved.

Distributed by:

Distributor by country on application